

SIDE SECT VIEW

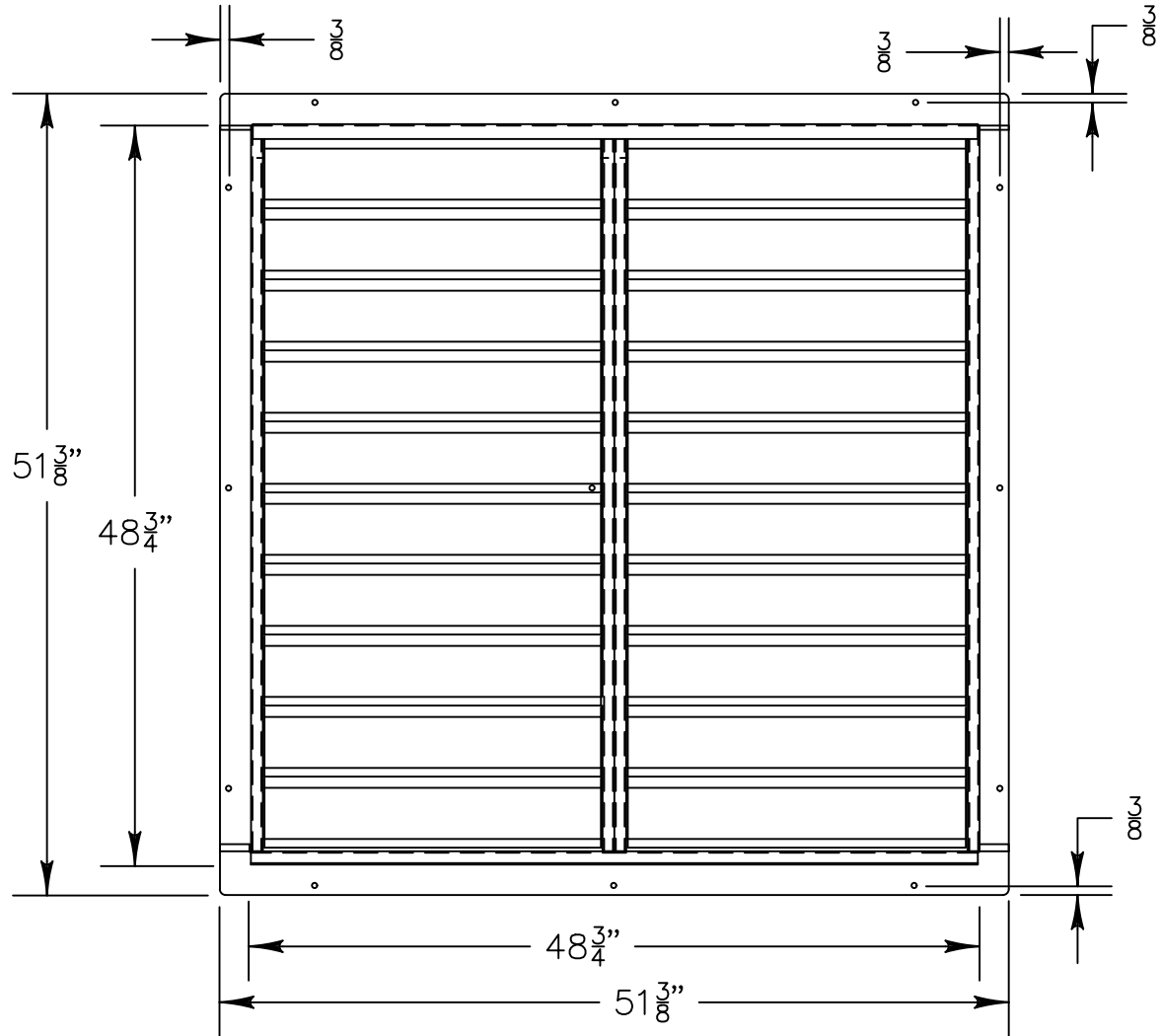

DISCHARGE VIEW

Shutter Specifications

Intended Use: Exhaust	Blade Material: Extruded Aluminum
Frame: Welded Galvanized Steel	Blade Thickness: .050"
Finish: Bronze Polyester Powder Coat	Bushings: Bronze Sintered
Mounting: Mounts directly to housing of VI48 and VID48 Series fans	
*See TriangleFans.com for performance specifications	
*Specifications are subject to change without notice	



IWSD45

NOT TO SCALE | 24 MAY 2013