

SIDE SECT VIEW

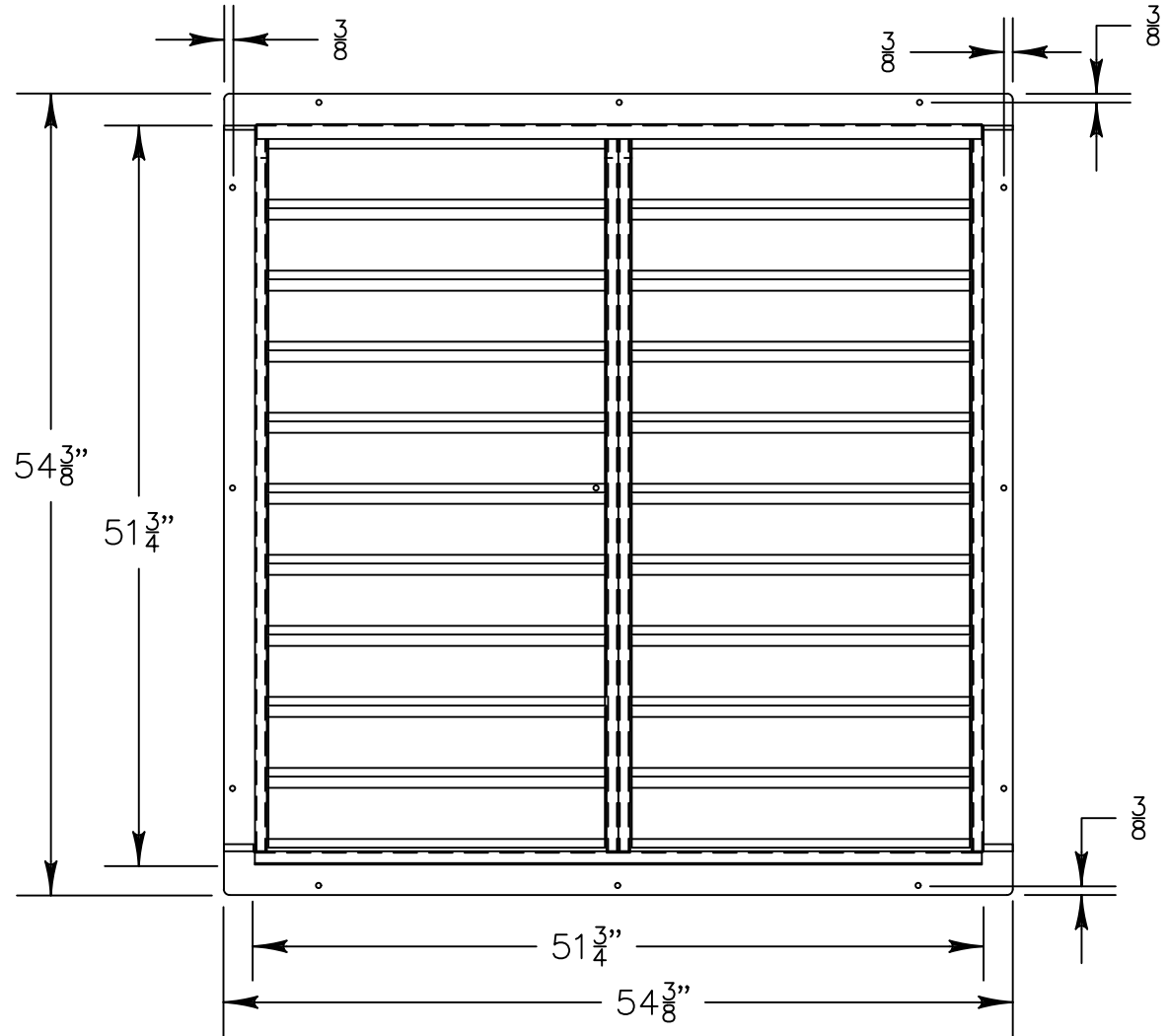

DISCHARGE VIEW

Shutter Specifications

Intended Use: Exhaust	Blade Material: Extruded Aluminum
Frame: Welded Galvanized Steel	Blade Thickness: .050"
Finish: Bronze Polyester Powder Coat	Bushings: Bronze Sintered
Mounting: Mounts to wall OVER a VI48 and VID48 Series fan	

*See TriangleFans.com for performance specifications
 *Specifications are subject to change without notice



IWSD48

NOT TO SCALE | 24 MAY 2013