

SIDE SECT VIEW

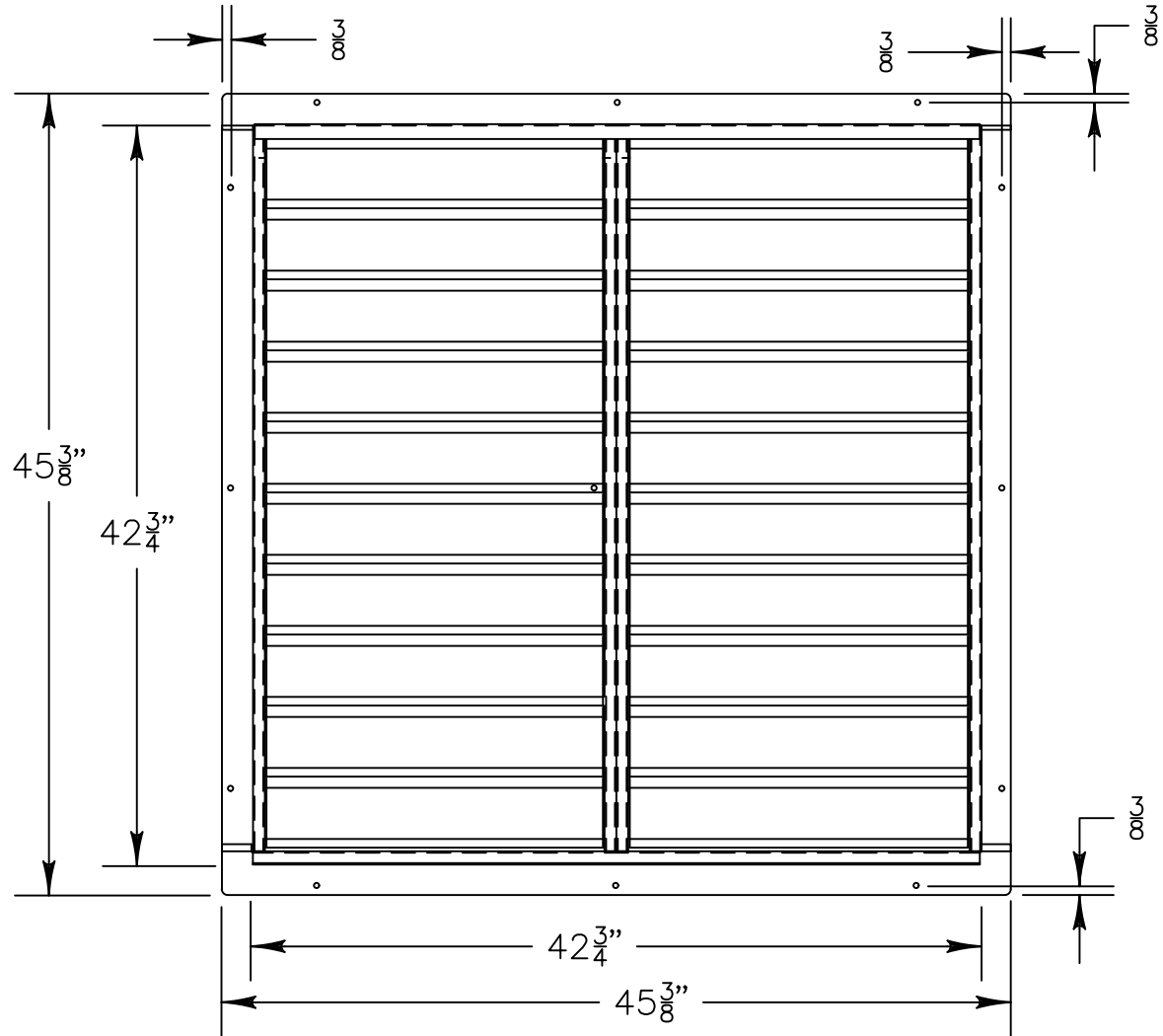

DISCHARGE VIEW

### Shutter Specifications

- |   |                                   |
|---|-----------------------------------|
| Intended Use: Supply  | Blade Material: Extruded Aluminum |
| Frame: Welded Galvanized Steel  | Blade Thickness: .050"            |
| Finish: Bronze Polyester Powder Coat  | Bushings: Bronze Sintered         |
| Mounting: Mounts directly to housing of RVI42 Series fans   |                                   |
| Note: Must be equipped with an operator and Shutter must be fully opened before fan is energized. Operator sold separately. |                                   |
| *See TriangleFans.com for performance specifications  |                                   |
| *Specifications are subject to change without notice  |                                   |



RIWSD39

NOT TO SCALE | 24 MAY 2013