

SIDE SECT VIEW

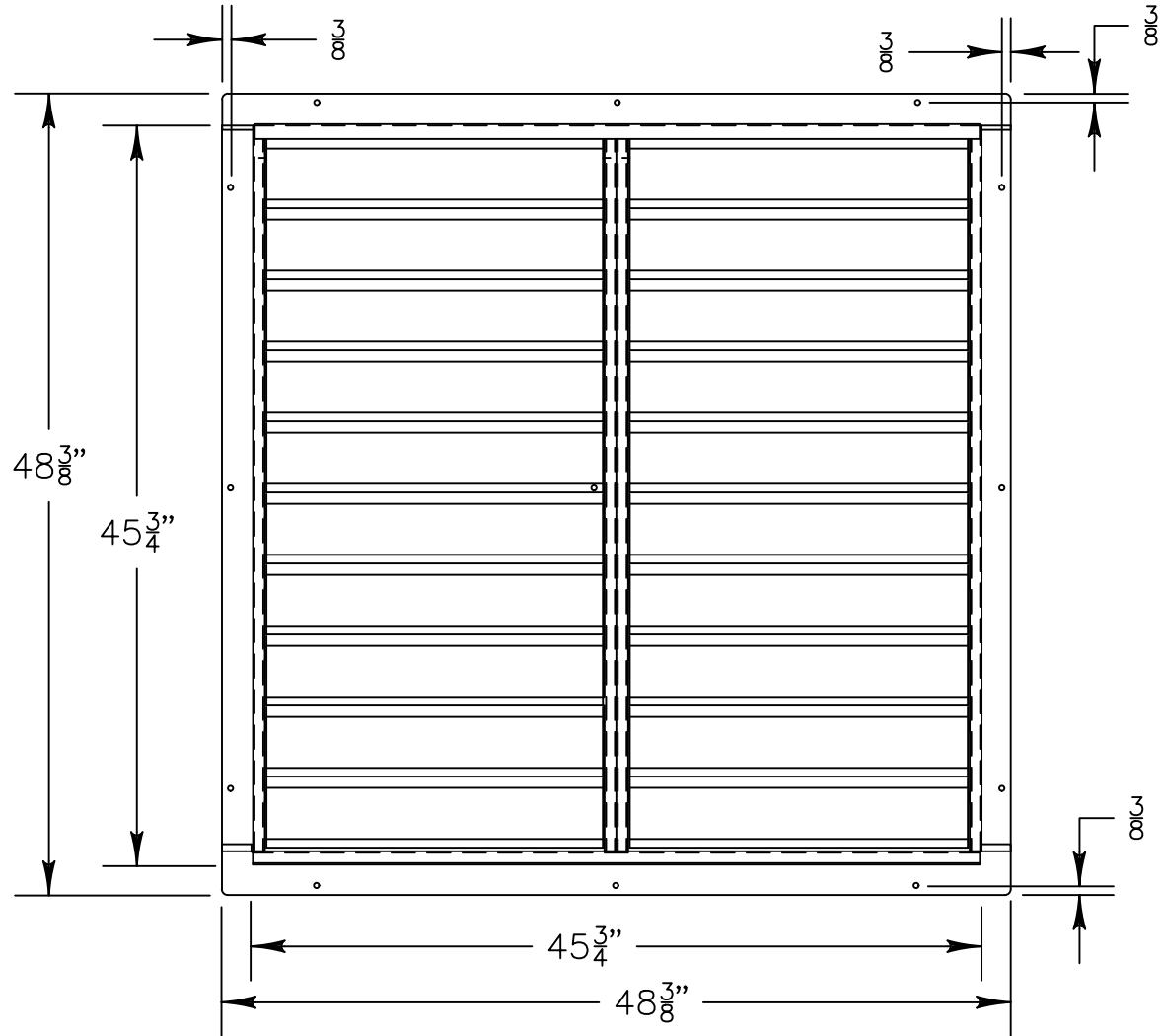

DISCHARGE VIEW

Shutter Specifications

- | | |
|---|-----------------------------------|
| Intended Use: Supply | Blade Material: Extruded Aluminum |
| Frame: Welded Galvanized Steel | Blade Thickness: .050" |
| Finish: Bronze Polyester Powder Coat | Bushings: Bronze Sintered |
| Mounting: Mounts to wall OVER a RVI42 Series fan | |
| Note: Must be equipped with an operator and Shutter must be fully opened before fan is energized. Operator sold separately. | |
| *See TriangleFans.com for performance specifications | |
| *Specifications are subject to change without notice | |



RIWSD42

NOT TO SCALE 24 MAY 2013