

INTAKE VIEW

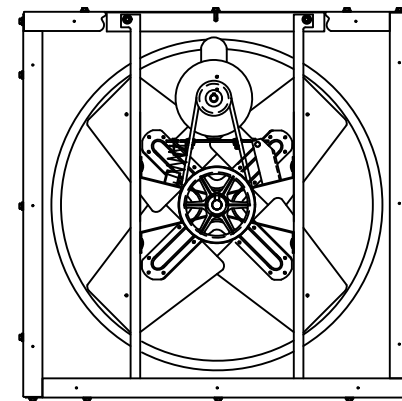
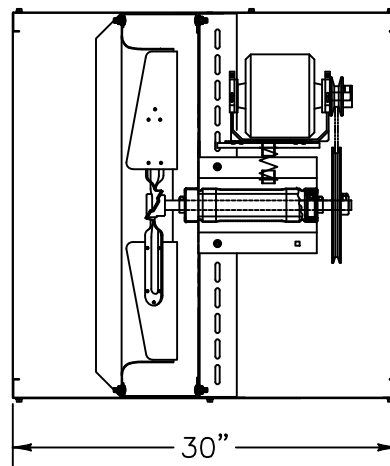

DISCHARGE VIEW

Supply Fan Specifications

Blade Diameter:	24"	Motor Enclosure:	ODP
Drive:	Belt	Duty Cycle:	Continuous Duty
Horsepower:	1/2	Guards:	N/A
Voltage:	115	Power Cord:	10' with molded plug
Phase:	1		
RPM:	840		

*See TriangleFans.com for performance specifications

*Specifications are subject to change without notice



RV12413-V

NOT TO SCALE | 1 OCT 2015