

INTAKE VIEW

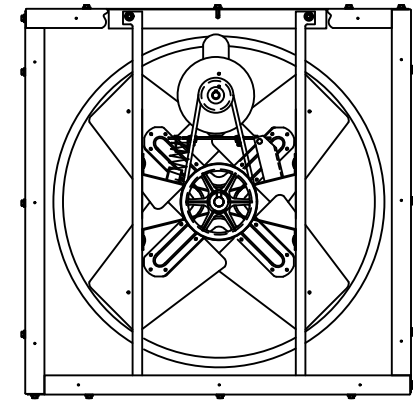
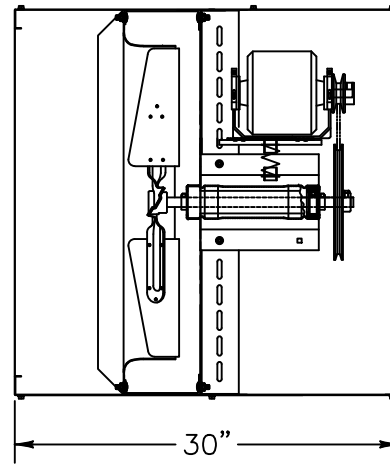

DISCHARGE VIEW

Supply Fan Specifications

Blade Diameter:	24"	Motor Enclosure:	ODP
Drive:	Belt	Duty Cycle:	Continuous Duty
Horsepower:	1/2	Guards:	N/A
Voltage:	230/460	Power Cord:	N/A
Phase:	3		
RPM:	840		

*See TriangleFans.com for performance specifications
 *Specifications are subject to change without notice

 TRIANGLE ENGINEERING	RV12413-X
	NOT TO SCALE 1 OCT 2015