

INTAKE VIEW

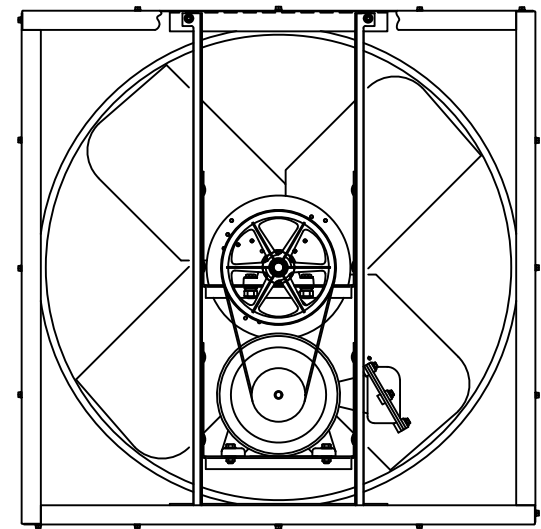
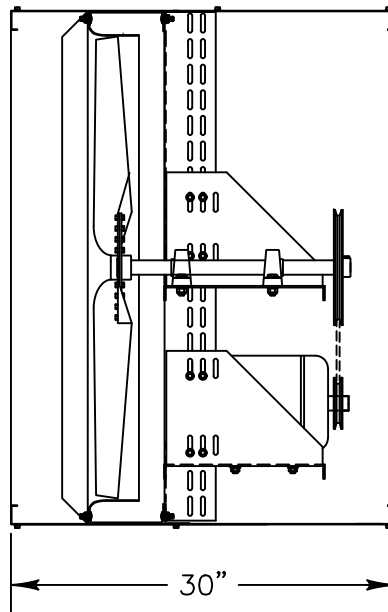

DISCHARGE VIEW

Supply Fan Specifications

Blade Diameter: 36"	Motor Enclosure: TEFC
Drive: Belt	Duty Cycle: Continuous Duty
Horsepower: 3	Guards: N/A
Voltage: 230/460	Power Cord: N/A
Phase: 3	
RPM: 835	

*See TriangleFans.com for performance specifications
 *Specifications are subject to change without notice



RVI3618T-X
 NOT TO SCALE | 28 SEP 2015