

INTAKE VIEW

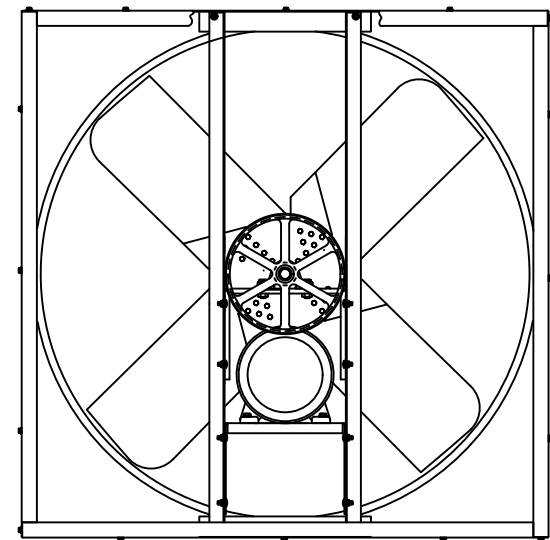
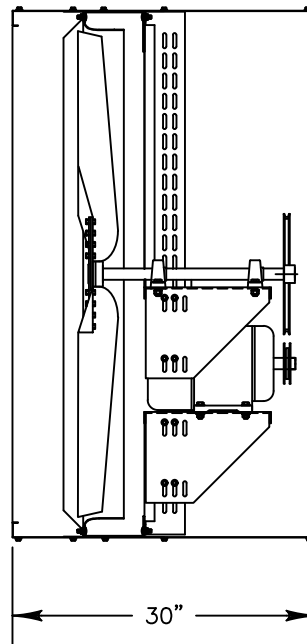

DISCHARGE VIEW

### Supply Fan Specifications

Blade Diameter:	54"	Motor Enclosure:	ODP
Drive:	Belt	Duty Cycle:	Continuous Duty
Horsepower:	5	Guards:	N/A
Voltage:	230/460	Power Cord:	N/A
Phase:	3		
RPM:	650		

\*See TriangleFans.com for performance specifications

\*Specifications are subject to change without notice



RVI5419-X

NOT TO SCALE | 7 OCT 2015