

DISCHARGE VIEW

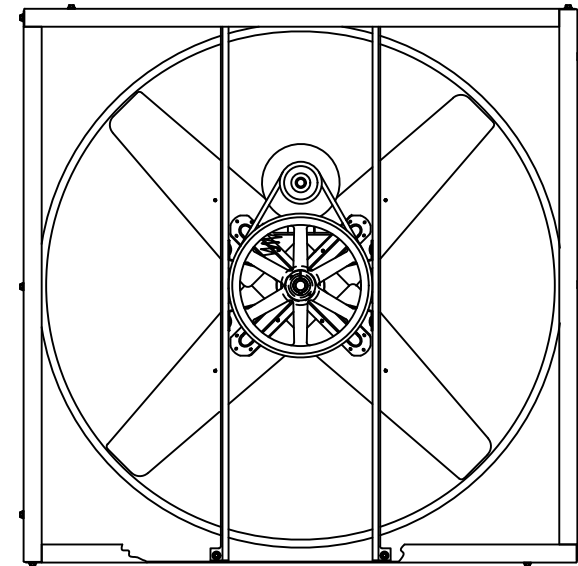
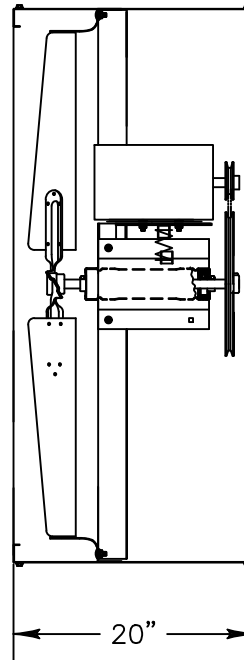

INTAKE VIEW

### Exhaust Fan Specifications

Blade Diameter:	36"	Motor Enclosure:	TEFC
Drive:	Belt	Duty Cycle:	Continuous Duty
Horsepower:	3/4	Guards:	N/A
Voltage:	115/230	Prewired:	115v
Phase:	1	Power Cord:	10' with molded plug
RPM:	540		

\*See TriangleFans.com for performance specifications

\*Specifications are subject to change without notice



VI3614T-U

NOT TO SCALE | 28 SEP 2015