

DISCHARGE VIEW

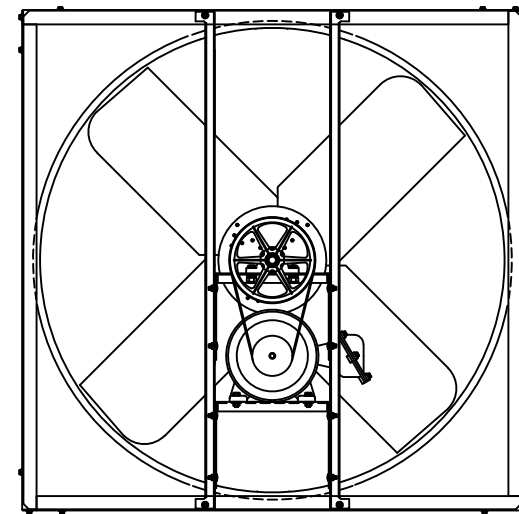
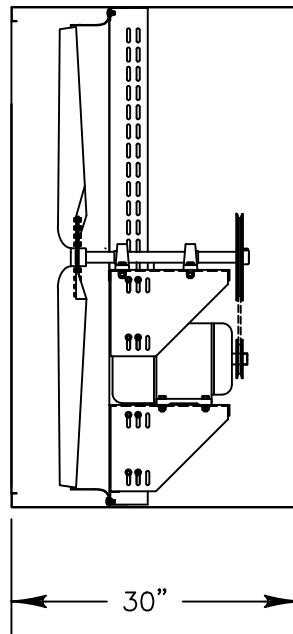

INTAKE VIEW

Exhaust Fan Specifications

Blade Diameter:	36"	Motor Enclosure:	TEFC
Drive:	Belt	Duty Cycle:	Continuous Duty
Horsepower:	3	Guards:	N/A
Voltage:	230/460	Power Cord:	N/A
Phase:	3		
RPM:	835		

*See TriangleFans.com for performance specifications
 *Specifications are subject to change without notice



VI3618T-X

NOT TO SCALE | 28 SEP 2015