

DISCHARGE VIEW

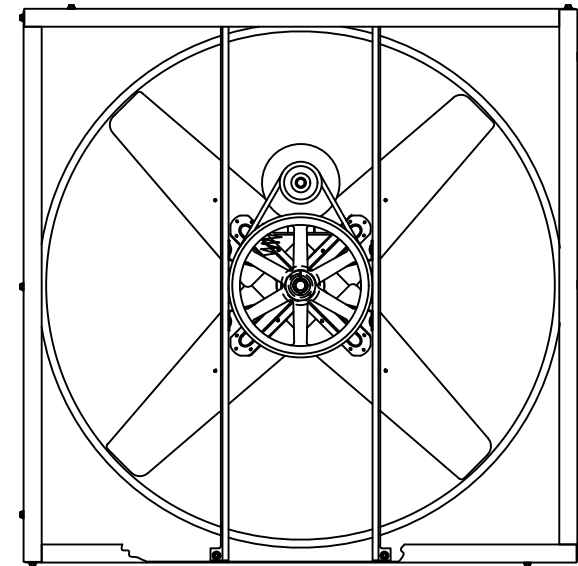

INTAKE VIEW

Exhaust Fan Specifications

Blade Diameter:	42"	Motor Enclosure:	ODP
Drive:	Belt	Duty Cycle:	Continuous Duty
Horsepower:	1.5	Guards:	N/A
Voltage:	115/230	Power Cord:	N/A
Phase:	1		
RPM:	500		

*See TriangleFans.com for performance specifications
 *Specifications are subject to change without notice



VI4216-U

NOT TO SCALE | 28 SEP 2015