

DISCHARGE VIEW

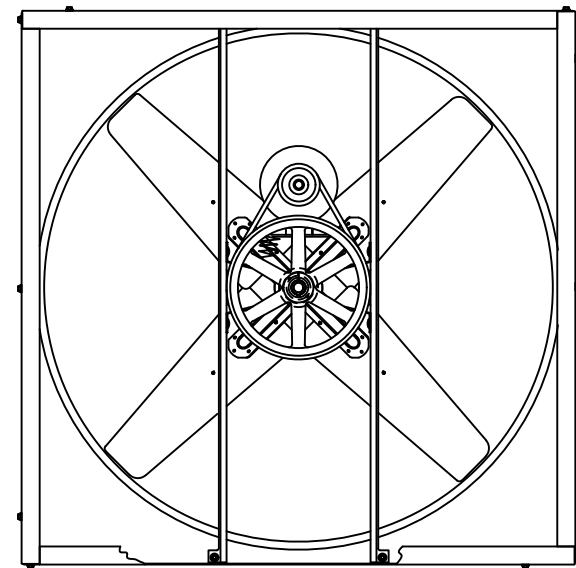
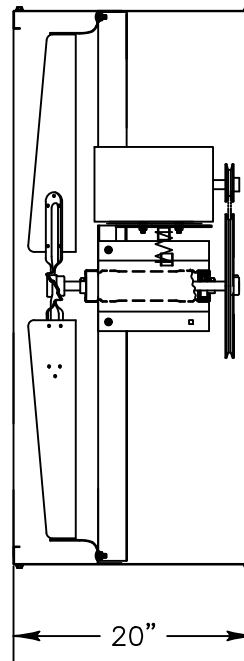

INTAKE VIEW

Exhaust Fan Specifications

| | | | |
|-----------------|---------|------------------|-----------------|
| Blade Diameter: | 48" | Motor Enclosure: | ODP |
| Drive: | Belt | Duty Cycle: | Continuous Duty |
| Horsepower: | 3/4 | Guards: | N/A |
| Voltage: | 230/460 | Power Cord: | N/A |
| Phase: | 3 | | |
| RPM: | 455 | | |

*See TriangleFans.com for performance specifications
 *Specifications are subject to change without notice



VI4814-X

NOT TO SCALE | 28 SEP 2015